



*Quick Start
Configuration Guide*

CT Safe Pro

Part Number: 0478-0481-01
Issue: 1

Original Instructions

For the purposes of compliance with the EU Machinery Directive 2006/42/EC, the English version of this manual is the Original Instructions. Manuals in other languages are Translations of the Original Instructions.

Documentation

Manuals are available to download from the following locations:

<http://www.drive-setup.com/ctdownloads>

The information contained in this manual is believed to be correct at the time of printing and does not form part of any contract. The manufacturer reserves the right to change the specification of the product and its performance, and the contents of the manual, without notice.

Warranty and Liability

In no event and under no circumstances shall the manufacturer be liable for damages and failures due to misuse, abuse, improper installation, or abnormal conditions of temperature, dust, or corrosion, or failures due to operation outside the published ratings. The manufacturer is not liable for consequential and incidental damages. Contact the supplier of the dive for full details of the warranty terms.

Environmental policy

Control Techniques Ltd operates an Environmental Management System (EMS) that conforms to the International Standard ISO 14001.

Further information on our Environmental Policy can be found at:

<http://www.drive-setup.com/environment>

Restriction of Hazardous Substances (RoHS)

The products covered by this manual comply with European and International regulations on the Restriction of Hazardous Substances including EU directive 2011/65/EU and the Chinese Administrative Measures for Restriction of Hazardous Substances in Electrical and Electronic Products.

Disposal and Recycling (WEEE)



When electronic products reach the end of their useful life, they must not be disposed of along with domestic waste but should be recycled by a specialist recycler of electronic equipment. Control Techniques products are designed to be easily dismantled into their major component parts for efficient recycling. The majority of materials used in the product are suitable for recycling.

Product packaging is of good quality and can be re-used. Large products are packed in wooden crates. Smaller products are packaged in strong cardboard cartons which have a high recycled fibre content. Cartons can be re-used and recycled. Polythene, used in protective film and bags for wrapping the product, can be recycled. When preparing to recycle or dispose of any product or packaging, please observe local legislation and best practice.

REACH legislation

EC Regulation 1907/2006 on the Registration, Evaluation, Authorisation and restriction of Chemicals (REACH) requires the supplier of an article to inform the recipient if it contains more than a specified proportion of any substance which is considered by the European Chemicals Agency (ECHA) to be a Substance of Very High Concern (SVHC) and is therefore listed by them as a candidate for compulsory authorisation.

Further information on our compliance with REACH can be found at:

<http://www.drive-setup.com/reach>

Registered Office

Nidec Control Techniques Ltd

The Gro

Newtown

Powys

SY16 3BE

UK

Registered in England and Wales. Company Reg. No. 01236886.

Copyright

The contents of this publication are believed to be correct at the time of printing. In the interests of a commitment to a policy of continuous development and improvement, the manufacturer reserves the right to change the specification of the product or its performance, or the contents of the guide, without notice.

All rights reserved. No parts of this guide may be reproduced or transmitted in any form or by any means, electrical or mechanical including photocopying, recording or by an information storage or retrieval system, without permission in writing from the publisher.

Copyright © March 2018 Nidec Control Techniques Ltd

Contents

1	Safety information	5
1.1	Warnings, Cautions and Notes	5
1.2	Important safety information. Hazards. Competence of designers and installers	5
1.3	Responsibility	5
1.4	Compliance with regulations	5
1.5	Electrical hazards	6
1.6	Stored electrical charge	6
1.7	Mechanical hazards	6
1.8	Access to equipment	6
1.9	Environmental limits	6
1.10	Hazardous environments	7
1.11	Motor	7
1.12	Mechanical brake control	7
1.13	Adjusting parameters	7
1.14	Electromagnetic compatibility (EMC)	7
2	Introduction	8
2.1	Intended use	8
2.2	Intended audience	8
2.3	Safety warning	8
3	Drive interfacing	9
3.1	Module data	9
3.2	Status messaging	9
4	Inputs	11
4.1	Input blocks	11
4.2	Input block errors	16
5	Outputs	18
5.1	Output set-up	18
5.2	Example outputs	20
6	Encoders	21
6.1	Encoder set-up (Sensor Interface Axis 1)	21
6.2	Encoder configuration error	21
7	Safety functions	23
7.1	Safe stop 1/2 (SSX)	23
7.2	Safe Operating Stop	26
7.3	Safe limited speed	29
7.4	Safe direction	31
7.5	Safe limited position	33
7.6	Safe Limited Increment	39
7.7	Safety function combined examples	41

1 Safety information

1.1 Warnings, Cautions and Notes



A Warning contains information which is essential for avoiding a safety hazard.



A Caution contains information which is necessary for avoiding a risk of damage to the product or other equipment.

NOTE

A Note contains information, which helps to ensure correct operation of the product.

1.2 Important safety information. Hazards. Competence of designers and installers

This guide applies to products which control electric motors either directly (drives) or indirectly (controllers, option modules and other auxiliary equipment and accessories). In all cases the hazards associated with powerful electrical drives are present, and all safety information relating to drives and associated equipment must be observed.

Specific warnings are given at the relevant places in this guide.

Drives and controllers are intended as components for professional incorporation into complete systems. If installed incorrectly they may present a safety hazard. The drive uses high voltages and currents, carries a high level of stored electrical energy, and is used to control equipment which can cause injury. Close attention is required to the electrical installation and the system design to avoid hazards either in normal operation or in the event of equipment malfunction. System design, installation, commissioning/start-up and maintenance must be carried out by personnel who have the necessary training and competence. They must read this safety information and this guide carefully.

1.3 Responsibility

It is the responsibility of the installer to ensure that the equipment is installed correctly with regard to all instructions given in this guide. They must give due consideration to the safety of the complete system, so as to avoid the risk of injury both in normal operation and in the event of a fault or of reasonably foreseeable misuse.

The manufacturer accepts no liability for any consequences resulting from inappropriate, negligent or incorrect installation of the equipment.

1.4 Compliance with regulations

The installer is responsible for complying with all relevant regulations, such as national wiring regulations, accident prevention regulations and electromagnetic compatibility (EMC) regulations. Particular attention must be given to the cross-sectional areas of conductors, the selection of fuses or other protection, and protective ground (earth) connections.

This guide contains instructions for achieving compliance with specific EMC standards.

All machinery to be supplied within the European Union in which this product is used must comply with the following directives:

2006/42/EC Safety of machinery.

2014/30/EU: Electromagnetic Compatibility.

1.5 Electrical hazards

The voltages used in the drive can cause severe electrical shock and/or burns, and could be lethal. Extreme care is necessary at all times when working with or adjacent to the drive. Hazardous voltage may be present in any of the following locations:

- AC and DC supply cables and connections
- Output cables and connections
- Many internal parts of the drive, and external option units

Unless otherwise indicated, control terminals are single insulated and must not be touched.

The supply must be disconnected by an approved electrical isolation device before gaining access to the electrical connections.

The STOP and Safe Torque Off functions of the drive do not isolate dangerous voltages from the output of the drive or from any external option unit.

The drive must be installed in accordance with the instructions given in this guide. Failure to observe the instructions could result in a fire hazard.

1.6 Stored electrical charge

The drive contains capacitors that remain charged to a potentially lethal voltage after the AC supply has been disconnected. If the drive has been energized, the AC supply must be isolated at least ten minutes before work may continue.

1.7 Mechanical hazards

Careful consideration must be given to the functions of the drive or controller which might result in a hazard, either through their intended behaviour or through incorrect operation due to a fault. In any application where a malfunction of the drive or its control system could lead to or allow damage, loss or injury, a risk analysis must be carried out, and where necessary, further measures taken to reduce the risk - for example, an over-speed protection device in case of failure of the speed control, or a fail-safe mechanical brake in case of loss of motor braking.

With the sole exception of the Safe Torque Off function, none of the drive functions must be used to ensure safety of personnel, i.e. they must not be used for safety-related functions.

The Safe Torque Off function may be used in a safety-related application. The system designer is responsible for ensuring that the complete system is safe and designed correctly according to the relevant safety standards.

The design of safety-related control systems must only be done by personnel with the required training and experience. The Safe Torque Off function will only ensure the safety of a machine if it is correctly incorporated into a complete safety system. The system must be subject to a risk assessment to confirm that the residual risk of an unsafe event is at an acceptable level for the application.

1.8 Access to equipment

Access must be restricted to authorized personnel only. Safety regulations which apply at the place of use must be complied with.

1.9 Environmental limits

Instructions in this guide regarding transport, storage, installation and use of the equipment must be complied with, including the specified environmental limits. This includes temperature, humidity, contamination, shock and vibration. Drives must not be subjected to excessive physical force.

1.10 Hazardous environments

The equipment must not be installed in a hazardous environment (i.e. a potentially explosive environment).

1.11 Motor

The safety of the motor under variable speed conditions must be ensured.

To avoid the risk of physical injury, do not exceed the maximum specified speed of the motor.

Low speeds may cause the motor to overheat because the cooling fan becomes less effective, causing a fire hazard. The motor should be installed with a protection thermistor. If necessary, an electric forced vent fan should be used.

The values of the motor parameters set in the drive affect the protection of the motor. The default values in the drive must not be relied upon. It is essential that the correct value is entered in the Motor Rated Current parameter.

1.12 Mechanical brake control

Any brake control functions are provided to allow well co-ordinated operation of an external brake with the drive. While both hardware and software are designed to high standards of quality and robustness, they are not intended for use as safety functions, i.e. where a fault or failure would result in a risk of injury. In any application where the incorrect operation of the brake release mechanism could result in injury, independent protection devices of proven integrity must also be incorporated.

1.13 Adjusting parameters

Some parameters have a profound effect on the operation of the drive. They must not be altered without careful consideration of the impact on the controlled system. Measures must be taken to prevent unwanted changes due to error or tampering.

1.14 Electromagnetic compatibility (EMC)

Installation instructions for a range of EMC environments are provided in the relevant Power Installation Guide. If the installation is poorly designed or other equipment does not comply with suitable standards for EMC, the product might cause or suffer from disturbance due to electromagnetic interaction with other equipment. It is the responsibility of the installer to ensure that the equipment or system into which the product is incorporated complies with the relevant EMC legislation in the place of use.

2 Introduction

2.1 Intended use

This guide is intended to provide detailed examples to assist in the development of SI-Safety / CT Safe Pro projects. It is not intended to replace the SI-Safety User Guide or Programming Manual which together provide complete details of the SI-Safety option module and the CT Safe Pro configuration software.

Details of the intended use of the SI-Safety and CT Safe Pro can be found in the relevant sections of the respective guides:

- Installation and Operating manual SI-Safety Module Part: 0478-0139-03
- Programming Manual of SM-Safety SI-Safety



No examples given in this document are suitable for implementation as part of a safety control system on a real machinery application. Examples are provided as a guide only to aid understanding of CT Safe Pro and how to implement a safety control system using CT Safe Pro. The examples do not represent customer specific or machine specific solutions. All real applications must meet the requirements of the relevant local safety legislation (For the EU, the Machinery Directive 2006/EC/42). A risk assessment in compliance with the requirements of 'ISO 12100 Safety of machinery. General principles for design. Risk assessment and risk reduction' or equivalent must be used to determine the safety requirements of the machinery application.

2.2 Intended audience

Only adequately competent and qualified personnel should design, install or commission safety systems using the SI-Safety or CT Safe Pro

2.3 Safety warning

Incorrect use or misuse can result in personal injury or damage or equipment.

NOTE

A **Note** contains information, which helps to ensure correct operation of the product.



A Warning contains information which is essential for avoiding a safety hazard.

3 Drive interfacing

Refer **Section 7.4 Diagnostic Parameters** of the SI-Safety Installation and Operating Manual for complete details of configuring RS-485 communications between the SI-Safety and a drive.

3.1 Module data

Module data is stored in parameters 20.012 to 20.014. Parameter 20.014 is used as a communications healthy check for data transfer between the SI-Safety module and the drive. If the parameter is incrementing between 0-255 data transfer is happening.

3.2 Status messaging

A maximum of 55 bits can be passed to the drive using the Message Channel Block. This icon  is used to insert the Message Channel Block.

Once inserted the Status Message Data can be configured. Any block can be added based on the block ID.

NOTE

After a block is added subsequent blocks which contain identical data are not able to be added.

**WARNING**

The data is packed into integers in Parameters 20.015 – 20.020. The bit sequence can be altered by modifying the Bit ID. This can result in data being in an unintended order.

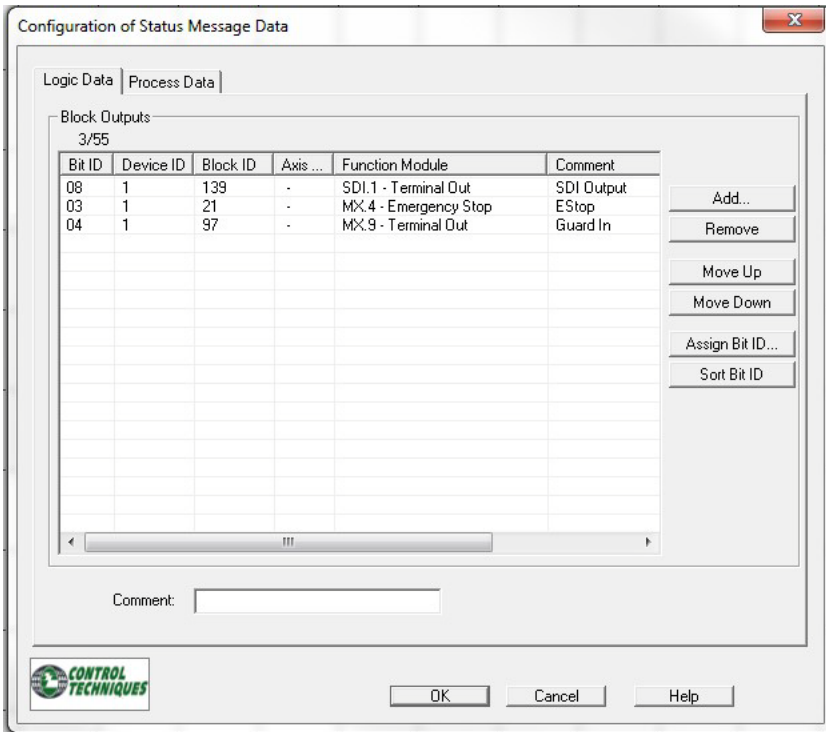

Programming

To connect to the SI-Safety a USB to RS-485 adapter is required. Once physically connected use "File – Open Connection Dialogue" to open the connection box.

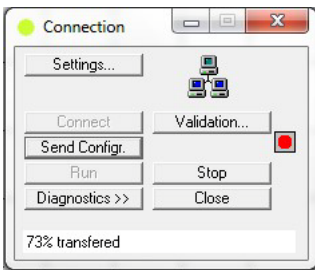

NOTE Cannot download to the SI-Safety if it is in an Error state. Must be in Stop State.

4 Inputs

There is one non-safe and four dual-safe digital inputs available. Inputs can be inserted by selecting any of the below icons from the Input Blocks menu.

4.1 Input blocks

A brief description of each input block including any differences from the common parameters.



Line Breaker: Used for Estops (Cannot have grouped complementary contacts)



Confirm Button: Used for enabling buttons or two-handed controls



Door Control: Used for interlocked gates or guards



Limit Switch: Used for travel limits (Cannot have monitored start or start test)



Lack of monitored start up limits applicability to limit switches that are used to interlock moveable guards.



Light Curtain: Used for light curtains, area scanners, usually will be OSSD devices.

NOTE

Disable cross check if using with OSSD device.



Sensor: Used for magnetic or RDIF safety switches for interlocked gates or guards. (Cannot have grouped complementary time monitored)

4.1.1 Safety element input blocks

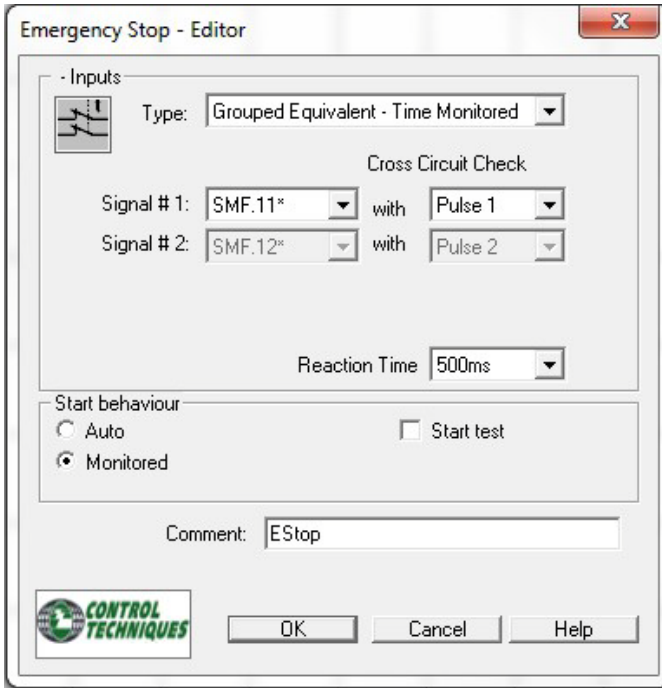

The common input parameters are:

Type:

Grouped equivalent: Dual normally closed contacts/normally high OSSD outputs

Grouped complementary (Anti-valent): Mechanically linked Normally Closed Normally Open Contacts

Time monitored (Reaction time): Configurable discrepancy time before input block faults

Start behaviour (Auto, Monitored, Start test):

Auto: The output of the input block immediately matches the input.

Monitored: The input block requires an external reset signal before the output can become TRUE



Monitored start up is usually required. It can be very dangerous to allow automatic resetting of a safety system and must only be done after careful design review and documentation. When using an SI/SM Safety module as a standalone safety controller monitored start up would be usually appropriate. When using an external safety PLC for the high level safety function control the safety logic in the PLC can implement the safety function reset and so automatic start up may be appropriate. Guidance must be taken from EN 12100, EN ISO 13489 and other relevant safety standards as to when automatic resetting of a safety system is acceptable.

NOTE See subsequent note about Alarm Reset in the Start Reset input section. Auto start behaviour is limited to the input block. The overall safety function may not be able to auto reset if a safety function block is used.

Start Test: On power up Input must be switched once before it can be reset.

NOTE Start test is available for a maximum of two dual channel inputs.

Cross circuit check (Pulse 1/2, OFF): If Pulse 1/2 are selected the input device must be a volt free contact and be connected on one side to the 24 V Pulse output on the safety module. If OFF is selected either an OSSD device or a plain 24 Vdc signal can be used.



When Cross circuit check is not enabled and an OSSD device is not in use extra care must be taken to prevent short circuits from 24VDC to the inputs. This can include protected wiring or fault exclusions. Guidance must be taken from EN ISO 13489-2 and other relevant safety standards.

Signal #1/ #2: Selection to determine where the signal will be wired into. If the input type is 'grouped' than only SMF.11/12, SMF.21/22, SMF.31/32, SMF.41/42 will be available. If input type is either of 1 N.O. or 1 N.C. the only choice is the non-safe input E0.5.

Start Reset

Start- / Reset switch - Editor
X

Start behaviour

use for monitored start up

Start Type: monitored

Inputs

Grouped Equivalent

Cross Circuit Check

Signal # 1: SMF.41* with OFF

Signal Nr. 2: SMF.42* mit OFF

Alarm Reset

use as Alarm Reset (N.O.)

use as Logic-Reset (N.O.)

Comment:



OK
Cancel
Help

Start reset input block can be used for resetting input blocks with monitored start enabled, resetting tripped safety functions and as a logic input in the continuous function chart.

Start behaviour

When use for monitored start up is enabled an output is added to the left side of the input block in terminal diagram mode. This must be connected to any safety input blocks that have Monitored Start behaviour enabled.

Alarm reset

When use as Alarm reset is enabled the reset input clears any non-fatal alarms and resets any tripped safety functions.

NOTE This is the only way to reset a tripped safety function. With SI-Safety the only safety function block that can be auto reset is the Safe Cam (SCA). All other safety function blocks require a Start reset input element with Alarm reset enabled.

When use as Logic-reset is enabled the reset input can be used as a logic input into the continuous function chart.

NOTE The Start reset block is triggered on the rising edge only. Continuous on signals will be ignored.



Start reset (Only available 1 N.O. or Grouped equivalent)

4.1.2 Terminal diagram

An EStop element, door control element, limit switch element and reset element have been used. The limit switch is used as a mode selection toggle. The reset is wired into a dual channel input because the single channel input E0.5 is taken.

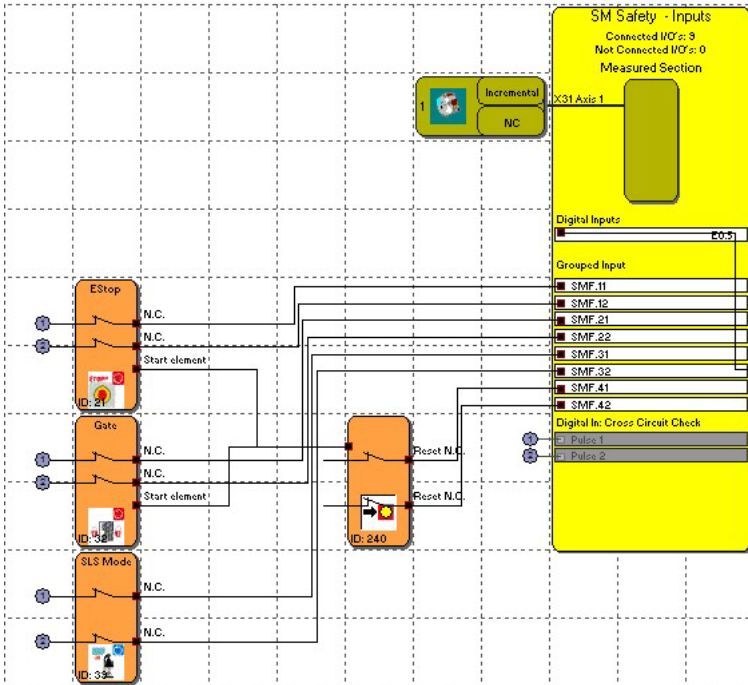

4.1.3 Continuous function chart

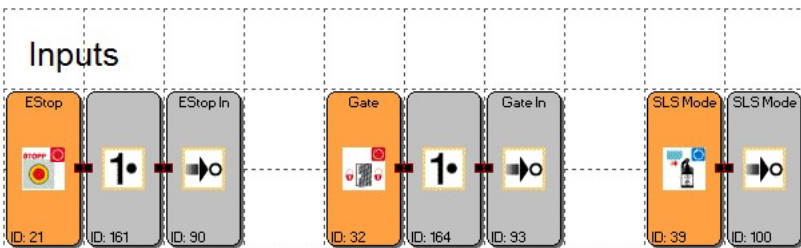

Each input is linked to an ITE (In Terminal Element). Depending on the logic requirements of downstream code it can be suitable to invert the input signal before linking to the ITE. Most safety devices are TRUE when in the safe state and FALSE when in the unsafe state. The safe monitoring functions are active when the input is TRUE. Thus to activate a safe monitoring function when the safety device is in the unsafe state (FALSE) the input will need to be inverted.



The use of a non-inverted signal from a safety input as the enable input for a safety function can allow the safety input to latch off but allow the safety function output to remain enabled resulting in a potentially dangerous situation.

4.2 Input block errors

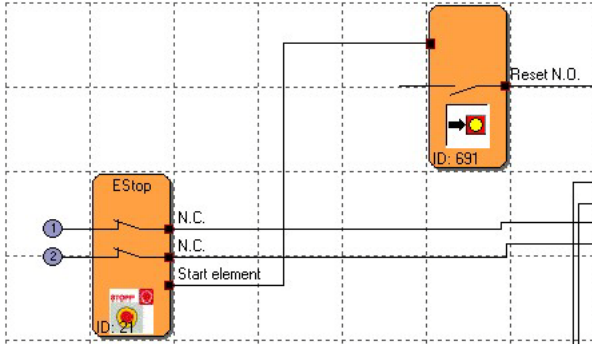

Correct connection between Reset element with use for monitored start up checked and the output connected to the Estop Start element input. The Estop has **Start behaviour monitored** checked.

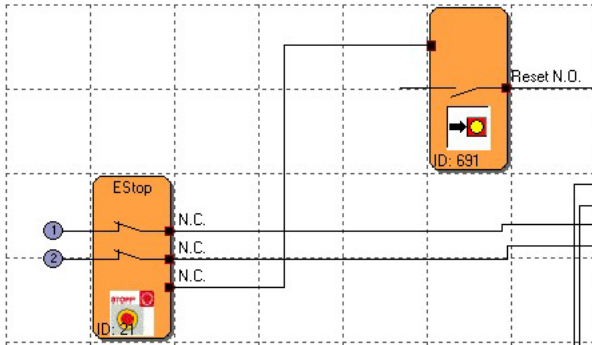

Error: The Estop has **Start behaviour auto** checked. The connection remains but the text has changed to N.C. The program can be compiled successfully.

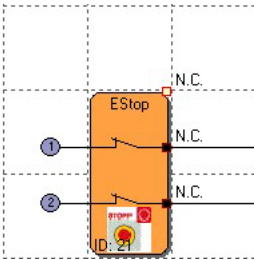

Error: The same as the above but the connection point has moved to the top right corner of the Estop block. When compiled the program will give the following error message:

```

Message Window
----- Start Plc-Check -----
14.08.2017, 11:16:56

BlockID:21Error: 1 not used Input(s)

found
1 error(s) 0 warning(s)

```



WARNING

In the above error the Estop appears to be configured for monitored start up but is configured for auto start up. This could lead to a dangerous situation where a safety function can auto reset and possibly restart without the expected reset procedures occurring.

5 Outputs

5.1 Output set-up

There are two non-safe and three safe digital outputs available. Outputs can be inserted by selecting either of the two below icons from the output blocks menu.

Digital function output element

This icon  allows for the insertion of a 'Digital function' output. These are either of the two non-safe outputs or the STO.

Output 1:

Output 1: can be either the safe torque off output STO.1, or a non-safe output A0.1 or A0.2.

EMU Monitoring is not an option with a Digital function output element and is always greyed out.

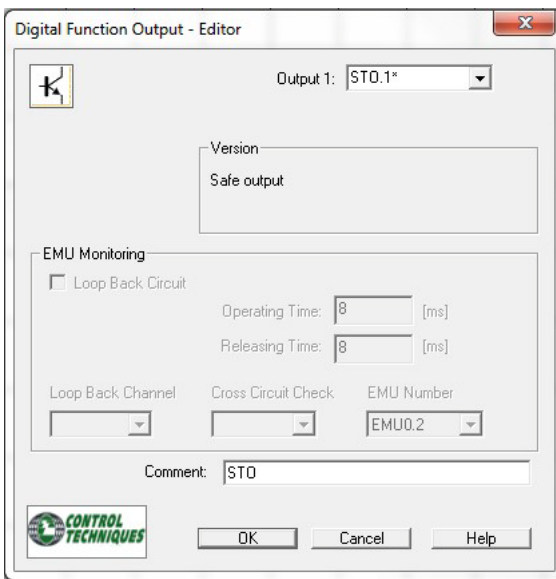

Digital safe output element

This icon  allows for the insertion of a 'Digital safe out' element. This is either of two single channel safe outputs or a single dual-channel output.

Output type

Standard (single channel safe out) or Redundant (dual channel safe out) can be selected.

Output 1: / Output 2:

SBC.1 or SBC.2 can be selected. If Redundant is checked both will be automatically selected.

EMU Monitoring

If Loop back circuit is enabled a non-safe digital will be automatically connected to input E.05.

Cross circuit check can be connected to either of the test pulses Pulse 1 or Pulse 2 or a 24 Vdc input. This allows for a feedback circuit to check correct operation of the safety device connected to the Digital safety output.

Operating time and Releasing time are the maximum times for the feedback input to transition TRUE to FALSE and vice versa. If the time exceeds these limits the EMU function block output will become FALSE.

EMU Monitoring is only available if Output type is Redundant.

Digital Safety Output - Editor

Output 1: SBC.1*

Output 2: SBC.2

Output Type:
 Standard
 Redundant

Version:
 Safe output

EMU Monitoring:
 Loop Back Circuit
 Operating Time: 8 [ms]
 Releasing Time: 8 [ms]

Loop Back Channel: E0.5*
 Cross Circuit Check: Pulse 1
 EMU Number: EMU0.1

Comment: Brake

OK Cancel Help

CONTROL TECHNIQUES

5.2 Example outputs

5.2.1 Terminal diagram

Two 'Digital function' output elements are connected. The one labelled *Feedback* is connected to the non-safe output A0.1. The one labelled *STO* is connected to the safe torque off output STO.1.

A dual channel 'Digital safety output' labelled *Brake* is connected to both of the safe outputs and has EMU monitoring enabled.

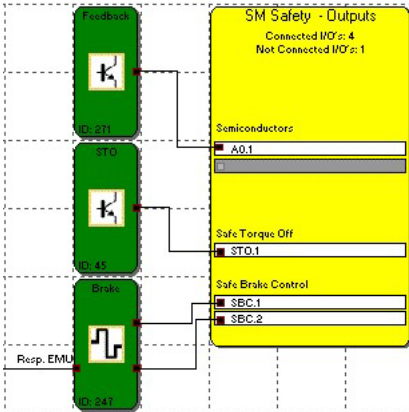

5.2.2 Continuous function chart

Outputs are neatly grouped. All OTEs (Out terminal element) that control the safe torque off are combined together with an AND block. In this example an external brake is closed when safe torque off is applied but is released after an on timer. This allows the motor to apply torque before the brake is released.

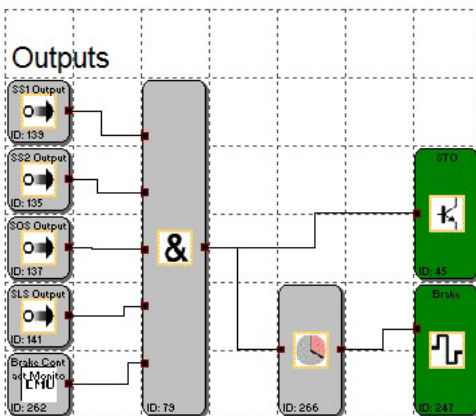

6 Encoders

6.1 Encoder set-up (Sensor Interface Axis 1)

See Programming Manual for details of encoder setup.

Sensor Configuration

Sensor Interface Axis 1

Parameter of working section

Linear Rotary sect. length: Position Processing
 Rotary degr/s Rev
 rev/sec rpm

Maximum Speed: rpm
 Cutoff Threshold Incr.: Rev Speed Filter:
 Cutoff Threshold Speed: rpm

Encoder 1

Interface Type:

Direction: Increasing Decreasing

Supply Voltage:

SSI-Interface: Masterclock Listener
 Listener

Data Bits:

Data Format: SSI-Binary SSI-GrayCode SSI-wCS

Resolution: Steps/Rev.
 Offset: Steps

Encoder 2

Interface Type:

Direction: Increasing Decreasing

Supply Voltage:

SSI-Interface: Masterclock Listener
 Listener

Data Bits:

Data Format: SSI-Binary SSI-GrayCode SSI-wCS

Resolution: Steps/Rev.
 Offset: Steps

6.2 Encoder configuration error

Fault code F1645/ F1646 occurs after attempting to run the program when a single encoder or type Incremental or SIN/COS is selected. It is caused by Position processing being checked in the box sect. length.

Message Window

```

Start connection..
13.06.2017, 09:43:21
Connected to device...
13.06.2017, 09:43:23
program started
13.06.2017, 09:43:28
F 1645 / F 1646: Range test of sensor configuration faulty [1646]
  
```

To fix this error:

1. Change the Interface Type of either encoder to Absolute. This will cause the check box to be available.
2. Uncheck Position Processing
3. Revert the Interface Type
4. Double check other parameters as some, including Supply Voltage, may be automatically modified due to changing the Interface Type.

NOTE

Changing the interface type will cause the supply voltage to be automatically reset to 24 V.

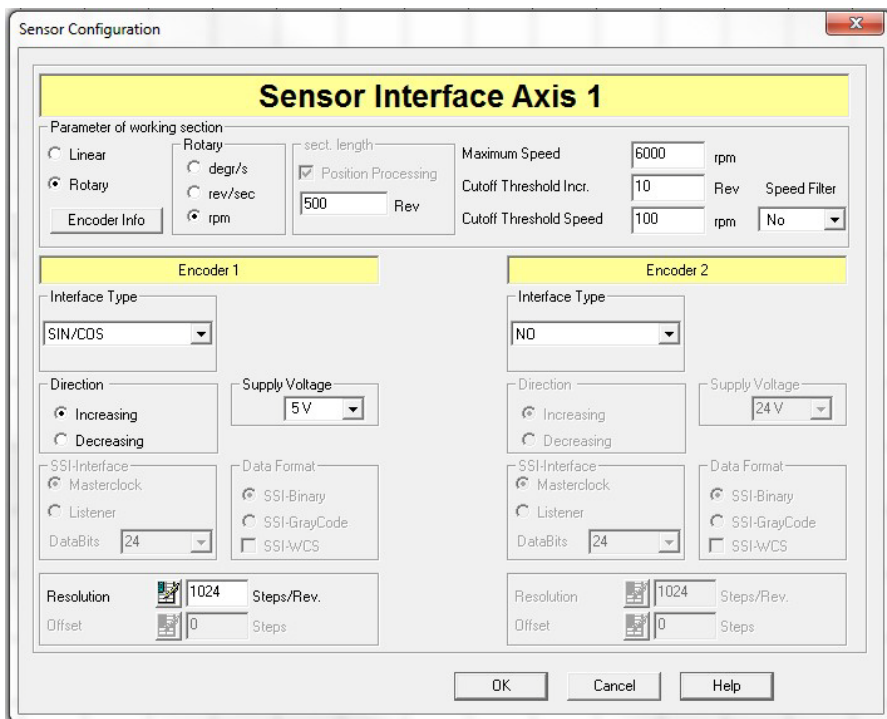

7 Safety functions

Fast Channel

When Use Fast Channel is enabled on an applicable safety function that safety function will directly control the SBC outputs (external safe digital outputs)

7.1 Safe stop 1/2 (SSX)



All measurement *units* will be automatically updated depending on encoder setup but *values* will remain unchanged. This may lead to unintended and/or unsafe behaviour.

7.1.1 Parameters

Stop category (see EN 61800-5-2 4.2.2.3)

Stop category 1 is a monitored deceleration followed by a safe torque off and/or brake activation.

Stop category 2 is a monitored deceleration followed by a safe operating stop.

An unmonitored Stop category 1 is also possible using only a timer and the STO output.

Latency time

The Standard latency time is the expected time delay between the input coming on and the motor beginning to decelerate. This time is dependent on method (hard wired, Ethernet, etc.) of instructing the drive to decelerate and internal processing time in the drive.

Linear curve profile

Selecting Linear curve profile means that the speed of the motor is expected to decelerate linearly beginning before the Standard latency time has passed and slowing with a minimum acceleration of Max. Acceleration.

S-Shape curve profile

Selecting S-Shape curve profile means that the speed of the motor is expected to decelerate below an S-Shaped curve beginning before the Standard latency time has passed. The S-Ramp Time defines the expected time before the motor has reached Max. Acceleration and subsequently the time to change from Max. Acceleration to zero speed.

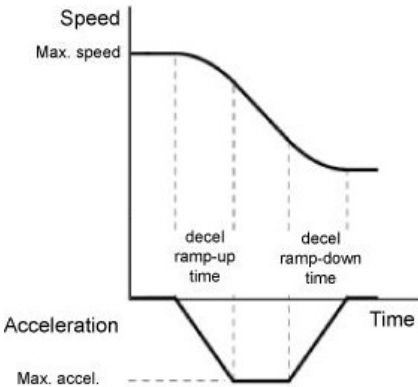

Speed threshold

Measured motor speed must remain under the expected speed based on the curve profile with an over tolerance of Speed threshold.

7.1.2 Example Safe Stop 1

NOTE This example is in **CTSafePro Example 1 SS1**.



No examples given in this document are suitable for implementation as part of a safety control system on a real machinery application. Please refer to section 2.1 *Intended use* on page 8 for further details.



In this example SS1 is used to implement an E-Stop function. The Estop OTE is connected to the input of the SSX block. If the input is FALSE the block is not active. A rising edge at the input (input becomes TRUE) activates the block. The output will remain TRUE during the deceleration

period unless the speed or acceleration go outside the limits of the stop curve – see SS1 setup. After the deceleration period the output will be FALSE.

SS1 Setup:

Stop Category 1 is selected, Curve profile is selected and the stopping conditions are inserted in the Threshold (Relative) box as per Safe Stop 1/2 (SSX).

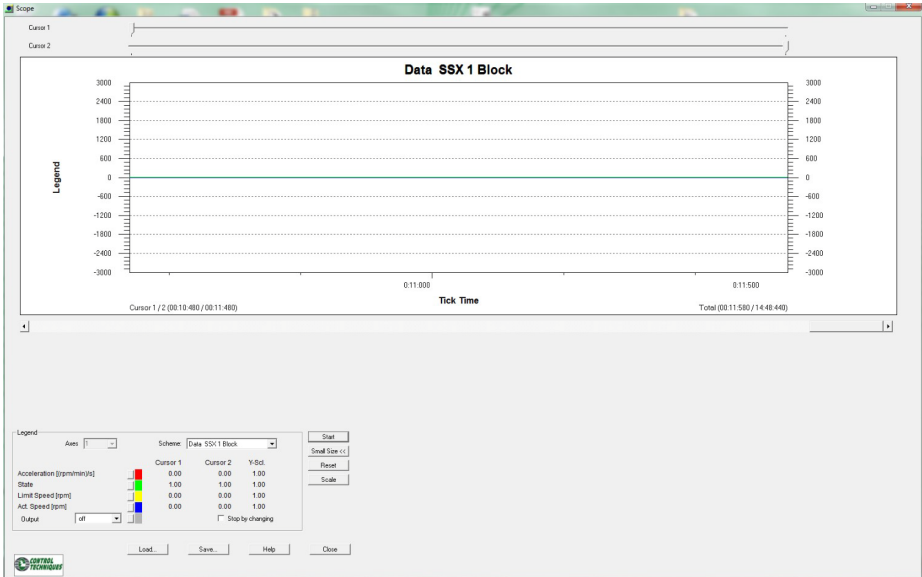

7.2 Safe Operating Stop



All measurement *units* will be automatically updated depending on encoder setup and monitoring type and *values* may be changed or remain unchanged. This may lead to unintended and/or unsafe behaviour.

Safe operating stop monitors that either the position or the speed and if necessary the acceleration stays within/under a defined tolerance. Safe operating stop must be used with Safe Stop 2.

7.2.1 Parameters

Monitoring type

The Monitoring type determines whether speed or position will be controlled and monitored. Use Fast Channel is described at the beginning of section Safety functions.

Speed tolerance

Speed Tolerance is the Maximum speed above zero that is allowed before activating the safety function.

Position tolerance

Position Tolerance is the Maximum deviation from the stopped position that is allowed before activating the safety function.

Acceleration monitoring

If Acceleration monitoring is enabled (activate is checked) the acceleration will also be monitored. Max. Acceleration is the maximum acceleration allowed before activating the safety function. Acceleration monitoring is automatically disabled if Use Fast Channel is enabled.

7.2.2 Example Safe Stop 2

NOTE This example is in **CTSafePro Example 2 SS2**.



No examples given in this document are suitable for implementation as part of a safety control system on a real machinery application. Please refer to section 2.1 *Intended use* on page 8 for further details.

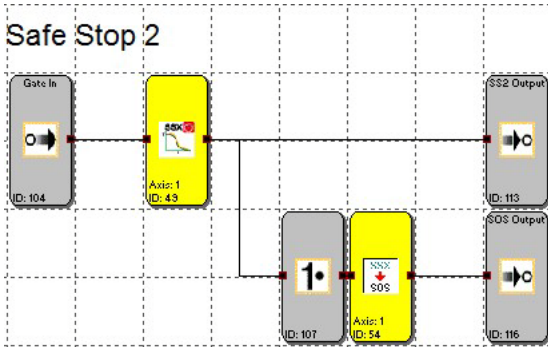

In this example SS2 is used to implement a gate access safe stop function. The Gate In OTE is connected to the input of the SSX block. If the input is FALSE the block is not active. A rising edge at the input (input becomes TRUE) activates the block. The output will remain TRUE during and after the deceleration period unless the speed or acceleration go outside the limits of the stop curve – see SS2 setup. The output of the SSX block is inverted and connected to the SOS block. The SOS block output remains TRUE unless the speed/acceleration/position exceeds the set tolerance or maximum.

NOTE SS2 must be used with SOS. The SOS block must be inserted first otherwise an error message will be displayed

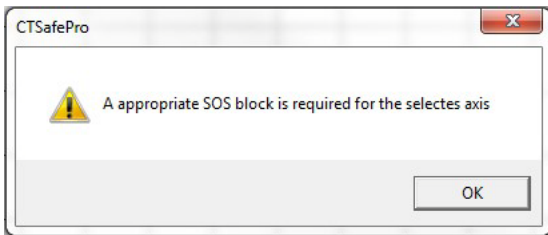

SS2 Setup:

Stop Category 2 is selected, Curve profile is selected and the stopping conditions are inserted in the Threshold (Relative) box as per Safe Stop 1/2 (SSX).

[SSX] Safe Stop 1/2 - Editor

Access_ID: 01 Axis1

Stop Category according to EN 60204-1

- 1 (Shut-off following expected standstill)
- 2 (SOS following expected standstill)

Curve profile type

- Linear
- S-Shape/Jerk-Limited

Threshold (Relative)

Standard latency time: 16 [ms]

Speed threshold: 5 [rpm]

Max. Acceleration: 200 [rpm/s]

S-Ramp Time: 8 [ms]

Comment:

OK Cancel Help

CONTROL TECHNIQUES

7.3 Safe limited speed



All measurement **units** will be automatically updated depending on encoder setup and **monitoring type** and **values** may be changed or remain unchanged. This may lead to unintended and/or unsafe behaviour.

The Safe Limited Speed monitors that either or both the speed and the acceleration stay under the set thresholds.

7.3.1 Parameters

Basic settings

Speed tolerance

Speed threshold is the maximum speed that is allowed before activating the safety function.

Acceleration monitoring

If Acceleration monitoring is enabled (activate is checked) the acceleration will also be monitored.

Max. Acceleration is the maximum acceleration allowed before activating the safety function.

Acceleration monitoring is automatically disabled if Use Fast Channel is enabled.

Enable unconditional

If Enable unconditional is checked the safety function is always monitoring and will be activated at any time the selected thresholds are exceeded.

NOTE ANY input connection must be removed before Enable unconditional can be checked.

Extended settings

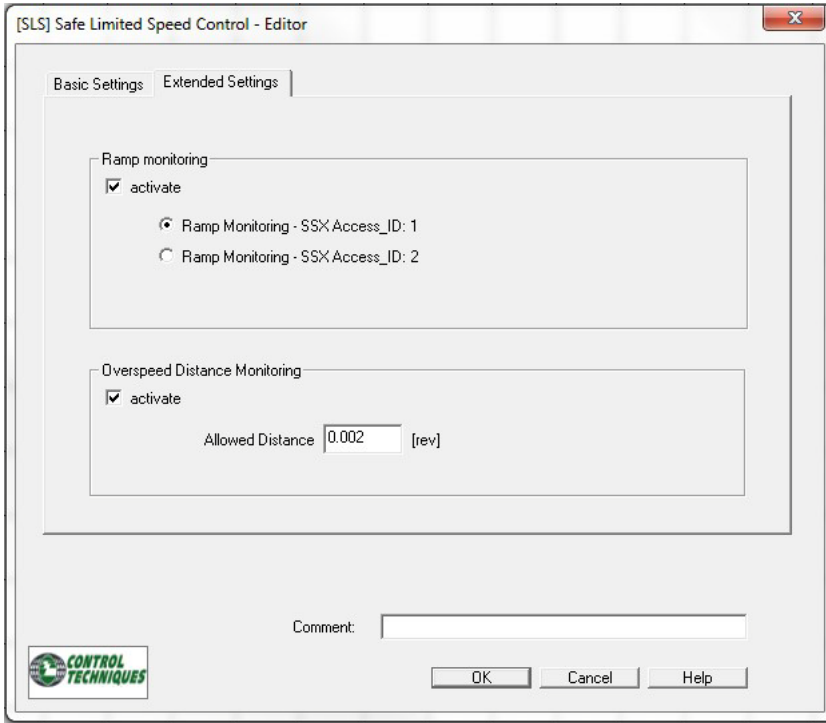

Ramp Monitoring

When ramp monitoring is active (activate is checked) it monitors the deceleration from the initial speed to the Speed threshold according to the ramp calculated in the selected SSX function.

NOTE Ramp monitoring must be used with Speed tolerance enabled and acceleration monitoring disabled.

Overspeed distance monitoring

When overspeed distance monitoring is active (activate is checked) it integrates the distance travelled when the speed is above Speed threshold. When the integral exceeds Allowed Distance the safety function is activated.

NOTE Overspeed distance monitoring must be used with Speed tolerance enabled.

7.3.2 Example Safe Limited Speed

NOTE

Ramp monitoring must be used with Speed tolerance enabled and acceleration monitoring disabled.



No examples given in this document are suitable for implementation as part of a safety control system on a real machinery application. Please refer to section 2.1 *Intended use* on page 8 for further details.

Safe Limited Speed

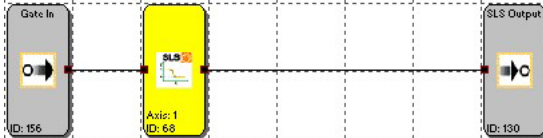

In this example SLS is used to implement a gate access safe limited speed function. The Gate In OTE is connected to the input of the SLS block. If the input is FALSE the block is not active. A rising edge at the input (input becomes TRUE) activates the block. The setup is as per the settings with all extended settings disabled. The output will remain TRUE unless the speed exceeds 30 rpm.

SLS Setup:

Speed tolerance is enabled (activate is checked) and the maximum speed is set in Speed threshold.

7.4 Safe direction



All measurement **units** will be automatically updated depending on encoder setup and monitoring type and **values** may be changed or remain unchanged. This may lead to unintended and/or unsafe behaviour.

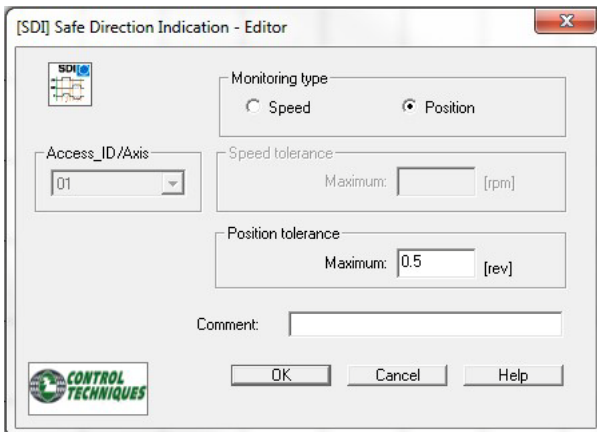

7.4.1 Parameters

Monitoring type

The Monitoring type determines whether speed or position will be controlled and monitored.

Speed tolerance

Maximum is the maximum speed in the safe direction that is allowed before activating the safety function. This allows SDI to be used as a mono-directional SLS function.

Position tolerance

Maximum is the maximum position deviation in the safe direction that is allowed before activating the safety function.

7.4.2 Example safe direction

NOTE This example is in **CTSafePro Example 4 SDI**.



No examples given in this document are suitable for implementation as part of a safety control system on a real machinery application. Please refer to section 2.1 *Intended use* on page 8 for further details.

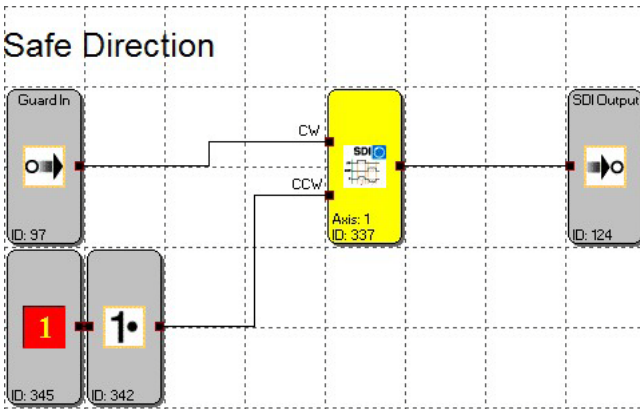

In this example SDI is used to implement a guard access safe direction function. The Guard In OTE is connected to the Clock Wise (CW) input of the SDI block. An Always TRUE block is inverted and connected to the Counter Clock Wise (CCW) input. If both inputs are FALSE the block is not active. A rising edge at either input (input becomes TRUE) activates safe direction monitoring in the relevant (CW, CCW) direction. The setup is as per the settings at the beginning of this section. The output will remain TRUE unless the position deviation after activation in the Clock Wise direction exceeds 0.5 Rev.

NOTE Both CW and CCW inputs being TRUE concurrently will cause a fault puts the safety program into an Alarm State. This will cause all of the safety outputs to be disabled.

7.5 Safe limited position

NOTE Position processing must be activated in the encoder configuration screen (Sensor Interface Axis 1).

NOTE If position processing is active and the position goes out of bounds (including negative) it can result in an unrecoverable error. Possible solutions to this are to physically move the axis back into bounds, reconfigure the encoder to give a different output, or make sure the SLP block does not directly control the safe outputs



All measurement **units** will be automatically updated depending on encoder setup and monitoring type and **values** may be changed or remain unchanged. This may lead to unintended and/or unsafe behaviour.

7.5.1 Parameters

Threshold (Relative)

Max. acceleration is the maximum allowable acceleration before activating the safety function.

S-Ramp Time is the acceleration ramp time used for calculating the S-shaped curve and limits the jerk.

Target position

Target position is the limit position. The safety function will be activated when actual position plus the calculated position required to ramp to stop equals the Target position.

Teach-in target position when checked selects teach in mode. In teach in mode the axis is moved to the target position and then the position is saved.

Position tolerance is the maximum deviation from the taught position before the safety function will be activated.

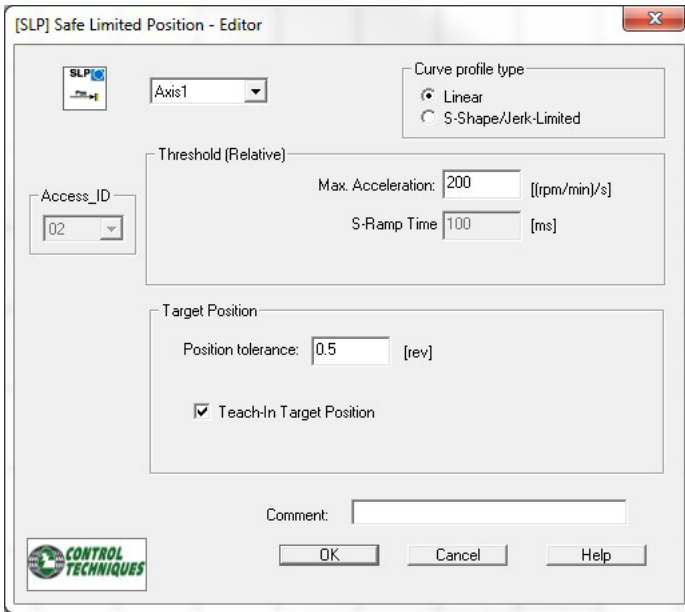

7.5.2 Inputs

Target position mode

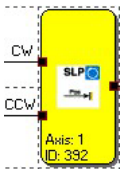

There are two inputs to SLP when it is configured in Target position mode. These are CW and CCW which are used to activate the block in either the clock wise (CW) or counter clock wise (CCW) directions.

Teach in mode

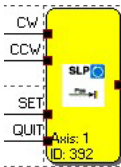

There are four inputs to SLP when it is configured in Teach in mode. These are CW and CCW which are used to activate the block in either the clock wise (CW) or counter clock wise (CCW) directions and SET and QUIT which are used for controlling the teach in. SET is a pulse to initiate the teach in capture and QUIT captures the position and ends the teach in.

NOTE

QUIT must be connected to an input element directly. See Example 3 Safe Limited Position with Teach In Example 3 Safe Limited Position with Teach In for an example of correct usage.

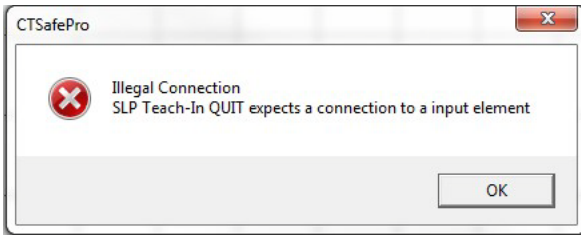

7.5.3 Example 1 safe limited position

NOTE This example is in **CTSafePro Example 5 SLP**.



No examples given in this document are suitable for implementation as part of a safety control system on a real machinery application. Please refer to section 2.1 *Intended use* on page 8 for further details.

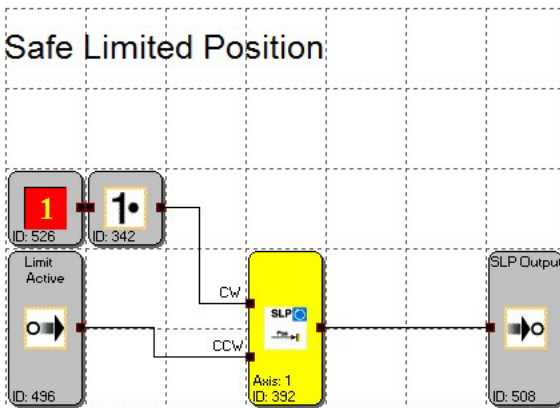

In this example safe limited position is used to implement an end of travel limit switch on the counter clockwise direction. The Limit Active OTE is connected to the Counter Clock Wise (CCW) input of the SLP block. An Always TRUE block is inverted and connected to the Clock Wise (CW) input. If both inputs are FALSE the block is not active. A rising edge at either input (input becomes TRUE) activates safe limited position monitoring in the relevant (CW, CCW) direction. The setup is as per the settings at the beginning of this section. The output will remain TRUE unless the position approaches too close (depending on set maximum acceleration) to the target position of 400 Rev.

NOTE Both CW and CCW inputs being TRUE concurrently will cause a fault puts the safety program into an Alarm State. This will cause all of the safety outputs to be disabled.

An always TRUE block can be used to activate SLP if the limit needs to be permanently active. The block can be reset as long as the limit is not exceeded. If it is exceeded it will not be resettable without intervention to bring the position back within the limit.



Using a safe input to activate the SLP block allows it to be overridden if outside the limit but gives the dangerous possibility of motion continuing past the limit, potentially resulting in injury, death or damage to property.

7.5.4 Example 2 safe limited position

NOTE This example is in **CTSafePro Example 6 SLP**.



No examples given in this document are suitable for implementation as part of a safety control system on a real machinery application. Please refer to section 2.1 *Intended use* on page 8 for further details.

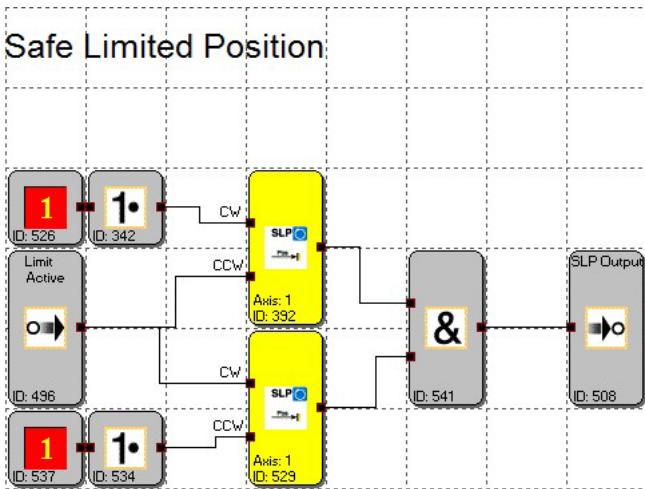

In this example safe limited position is used to implement end of travel limit switches in both directions. The Limit Active OTE is connected to the Counter Clock Wise (CCW) input of one SLP block and the Clock Wise (CW) input of the other block. An Always TRUE block is inverted and connected to the other inputs. If both inputs are FALSE the blocks are not active. A rising edge at either input (input becomes TRUE) activates safe limited position monitoring in the relevant (CW, CCW) direction. The setup is as per the settings at the beginning of this section. The output will remain TRUE unless the position approaches too close (depending on set maximum acceleration) to the target position of 400 Rev in the CCW direction or 425 Rev in the CW direction.

SET, QUIT and the SOS block are configured to achieve signal timing in accordance with the Time characteristic of the SET/QUIT process diagram in the programming manual. Both are directly connected in an input block although this is only required of the QUIT input. Both must be Normally Closed contacts or other devices that output a logic high/ 24 V usually and output logic low/ 0V when activated or depressed. The on delay timer is set to 1 second.

To teach in a target position:

- Axis must be stationary. Any movement will cause the SOS safety function to activate and disable the safe outputs.
- Activate SET briefly (under 500ms)
- Activate QUIT within the on delay timer time, but after deactivating SET.

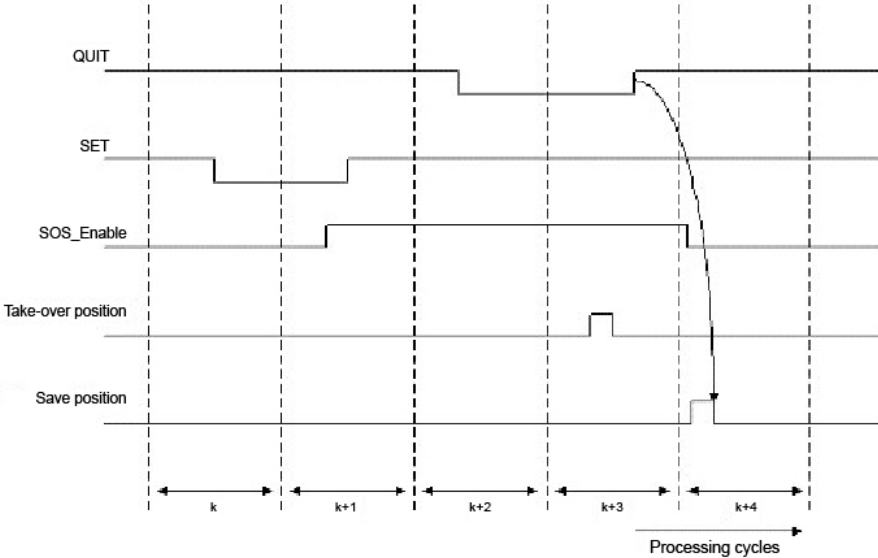

7.6 Safe Limited Increment



All measurement **units** will be automatically updated depending on encoder setup and **monitoring type** and **values** may be changed or remain unchanged. This may lead to unintended and/or unsafe behaviour.

7.6.1 Parameters

Threshold (Relative)

Jog Step is the maximum allowable travel in the forward direction before activating the safety function.

XI Threshold is the maximum allowable travel in the reverse direction before activating the safety function.

NOTE Input values for Jog Step and XI Threshold are limited based on the encoder setup and units selected. The minimum is always 1.000000 irrespective of units selected. This means that the minimum can be 1 deg, 1 mm, 1 m or 1 rev.

7.6.2 Example safe limited increment

NOTE This example is in **CTSafePro Example 9 SLI**.



No examples given in this document are suitable for implementation as part of a safety control system on a real machinery application. Please refer to section 2.1 *Intended use* on page 8 for further details.

Safe Limited Increment

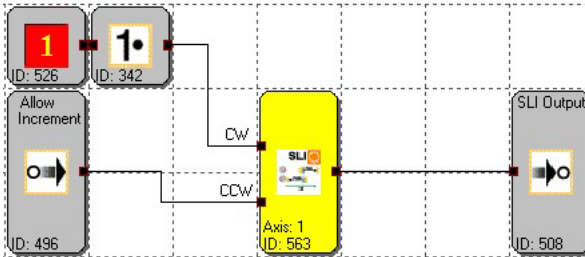

In this example safe limited increment is used to implement a safe jogging function in the counter clockwise direction. The Allow Increment OTE is connected to the Counter Clock Wise (CCW) input of the SLI block. An Always TRUE block is inverted and connected to the Clock Wise (CW) input. If both inputs are FALSE the block is not active. A rising edge at either input (input becomes TRUE) activates safe limited increment monitoring in the relevant (CW, CCW) direction. The setup is as per the settings at the beginning of this section. The output will remain TRUE until the position is greater than the initial position plus the Jog Step if travelling in the activated direction, and will remain TRUE while the position remains greater than the initial position minus the XI Threshold if travelling in the opposite direction.

NOTE Both CW and CCW inputs being TRUE concurrently will cause a fault puts the safety program into an Alarm State. This will cause all of the safety outputs to be disabled.



Usually the SLI enabling input will need to be inverted before being linked into the SLI inputs. Otherwise the input block will latch off after a trip (until reset) and allow unrestricted movement independent of the input state.

7.7 Safety function combined examples

7.7.1 Example 1 safe stop 2 and safe limited speed with mode selection

NOTE

This example is in **CTSafePro Example 7 SS2 + SLS**.



No examples given in this document are suitable for implementation as part of a safety control system on a real machinery application. Please refer to section 2.1 *Intended use* on page 8 for further details.

Safe Stop 2

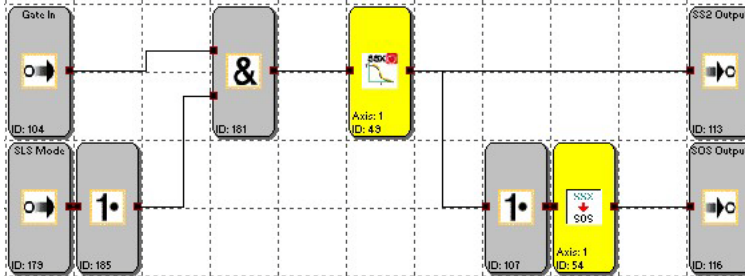

Safe Limited Speed



In this example Safe Stop 2 is combined with Safe Limited Speed. The SLS mode switch is used to switch between the two safety functions. When SLS Mode is TRUE, opening the gate (Gate IN is FALSE) will activate SLS. When SLS Mode is FALSE, opening the gate (Gate IN is FALSE), will activate the Safe Stop 2 safety function.

7.7.2 Example 2 Safe Limited Position with Safe Direction

NOTE This example is in **CTSafePro Example 8 SLP + SDI**.



No examples given in this document are suitable for implementation as part of a safety control system on a real machinery application. Please refer to section 2.1 *Intended use* on page 8 for further details.

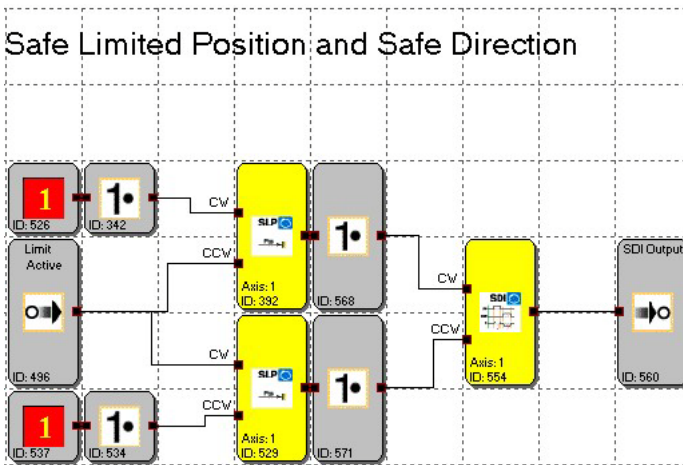

In this example Safety Limited Position is combined with Safe Direction to achieve end of travel limits but still allowing safe travel away from the limit.

NOTE An always TRUE block can be used to activate SLP if the limit needs to be permanently active. The block can be reset as long as the limit is not exceeded. If it is exceeded it will not be resettable without intervention to bring the position back within the limit.



Using a safe input to activate the SLP block allows it to be overridden if outside the limit but gives the dangerous possibility of motion continuing past the limit, potentially resulting in injury, death or damage to property.

7.7.3 Example 3 safe gate access and safely limited increment

NOTE This example is in **CTSafePro Example 10 SLI + SGA**



No examples given in this document are suitable for implementation as part of a safety control system on a real machinery application. Please refer to section 2.1 *Intended use* on page 8 for further details.

Safe Gate Access and Safely Limited Increment

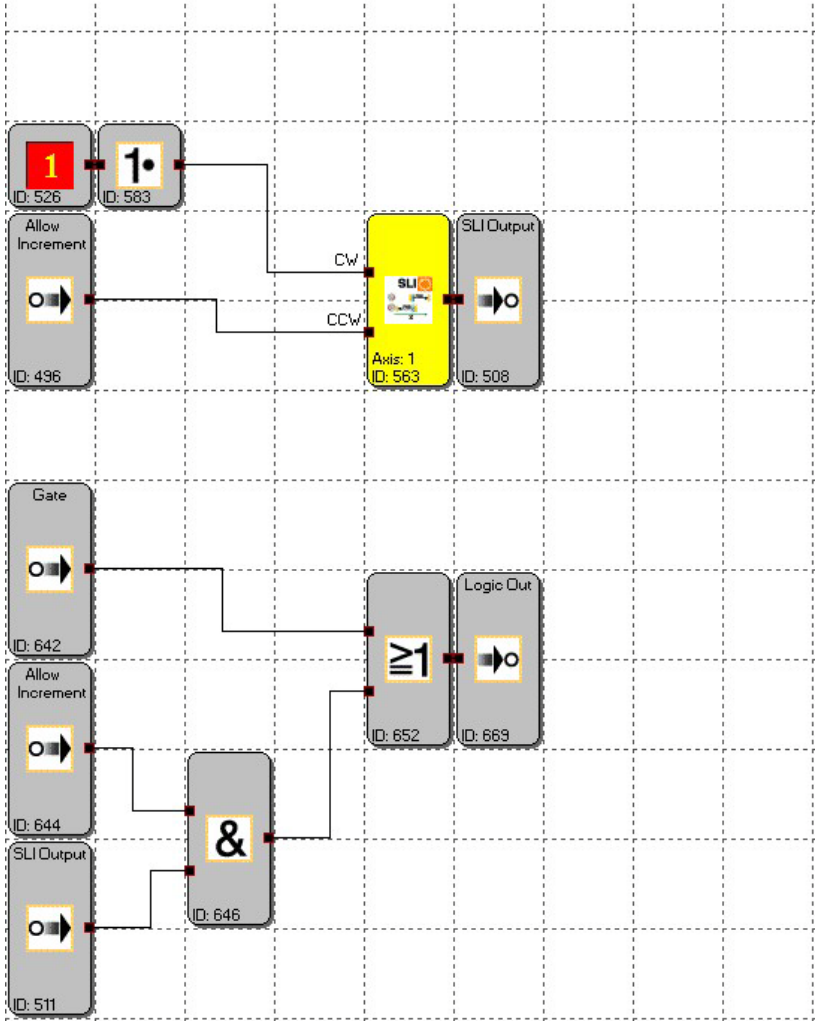

In this example Safe Gate Access (Gate OTE) is combined with Safe Limited Increment. In normal operation when the gate is opened (Gate In is FALSE) Logic Out will become FALSE which controls the STO and Brake Outputs.

If Safe Limited Increment is enabled (Allow Increment is TRUE), and any subsequent movement is less than the SLI Jog Step value than Logic Out will become TRUE. If the movement is greater than Jog Step, Logic Out will become FALSE disabling the safety outputs. If used for a jogging function, each time there is a movement the Allow Increment OTE must be disabled and enabled (TRUE – FALSE – TRUE) to allow another movement without tripping the safety function and thus requiring a reset input.



0478-0481-01